

# Specifications

## 技術規格

Outside Dimensions / 外形尺寸 (Width×Depth×Height / 闊×深×高)	500 mm×515 mm×873 mm (不包括排水管尺寸)
Weight / 重量	27 kg
Power Source / 電壓	220 V ~ 50 Hz
Power Consumption/ 消耗功率	300 W
Inlet Water Pressure/供水壓	0.03 - 0.8 MPa

\* Specifications subject to change without notice.

\* 如有技術變動，恕不另行通知。

**FOR WASHER WITH A 13 Amp. PLUG TOP 3 PIN**  
對於附有 13 安培三腳插頭的洗衣機

**⚠ WARNING 警告**

**This appliance must be earthed**  
**本電器必須接地**

**IMPORTANT** The wires in this mains lead are coloured in accordance with the following code:

Green/Yellow : Earth  
Blue : Neutral  
Brown : Live

As the colours of the wires in the mains lead of this appliance may not correspond with the coloured markings identifying the terminals in your plug, proceed as follows:

- The wire which is coloured green and yellow must be connected to the terminal in the plug which is marked with the letter E or by the earth symbol  $\perp$ , or coloured green or green and yellow.
- The wire which is coloured blue must be connected to the terminal which is marked with the letter N or coloured black.
- The wire which is coloured brown must be connected to the terminal which is marked with the letter L or coloured red.

**重要事項** 電源線的電線是根據以下的顏色表示：  
綠黃：地線  
藍：中性線  
棕：火線

由於本電器電源線的這些電線的顏色不一定和您的插頭終端上的顏色標誌相同，所以您應該採取以下步驟：

- 綠黃色電線應該連接至插頭上標明英文字母E或地線號  $\perp$  或顏色是綠色或綠黃色的終端。
- 藍色電線應該連接至插頭上標明英文字母N或顏色是黑色的終端。
- 棕色電線應該連接至插頭上標明英文字母L或顏色是紅色的終端。

 **Bondini**

# Instruction Manual

## 使用說明書

Microcomputer Control  
Fully Automatic Washing Machine  
(Domestic use)  
全自動洗衣機  
(家用)

Model No.

**BFA5500**

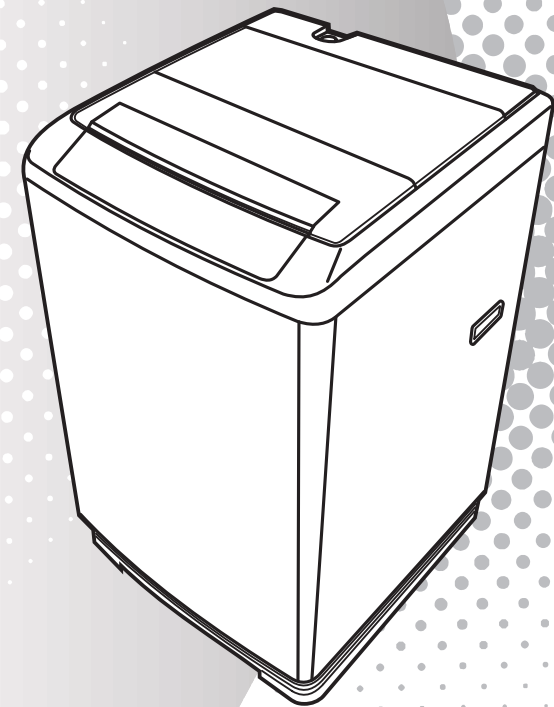

Thank you very much for purchasing Bondini product.  
非常感謝您購買了Bondini產品。

 Before operating this washing machine, please read these instructions carefully and completely, paying special attentions to notes pertaining to your particular model.

在使用此洗衣機前，請仔細閱讀全本使用說明書，並留心有關型號的注意事項。

# CONTENTS

## Read this before using this product

IMPORTANT SAFEGUARDS	2 - 4
CARE AND MAINTENANCE	4
ACCESSORIES	5
NAME OF PARTS	5
INSTALLATION INSTRUCTIONS	2 -10
NAMES AND FUNCTIONS OF CONTROL PANEL	11-12

## Quick Reference

NORMAL USAGE	13
HOW TO USE PROGRAM AND PROCESS	14-15
THE PREPARATION OF LAUNDRY BEFORE WASHING	15

## Advanced Functions

VARIOUS FUNCTIONS	
WATER LEVEL SETTING	16
TWO CLEAN STEPS FUNCTION	16
REMEMBER FUNCTION	16
CHILD LOCK FUNCTION	16
DELETE THE END BUZZER	16

## If Necessary



TROUBLE SHOOTING GUIDE	17
NO TROUBLE CONDITIONS	18
SPECIFICATIONS	Back Cover

# Important Safeguards

Please follow strictly

Please read this instructions manual carefully before using your machine.

The precautions stated here are classified as "Warning" and "Attention" according to the damage and the emergency caused by mis-operation, and are described respectively in line with the marks below.

 <b>WARNING</b>	Mis-operation may cause death
 <b>ATTENTION</b>	Mis-operation may cause body injury or damage the machine.

The items which need to be followed are differentiated and explained according to the following mark.

		
This mark indicates the content of warning or attention.	This mark indicates the prohibited action.	This mark indicates the compulsory action to be carried out.

## WARNING

### For power plug and cord

This washing machine is equipped with a 3 pin plug which includes an earthing wire. This appliance must be earthed.

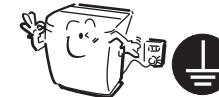

Electricity supply must be unplugged with dry hands. (Otherwise, this may cause electric shock.)



Damaged or losses wire or plug should not be used. (Otherwise electric shock, short circuit or fire may take place.)



Do not damage wire. Do not damage or alter the wire forcibly bend, pull twist or handle the wire. Beside, please do not put weigh on trap the wire. (Damage of wire may case electric shock or fire.)



### For tub and main unit

Keep child away from the washing spinning basket and do not place box or shelves next to the washing machine.

Children may fall into the basket resulting in injuries.



This appliance is not intended for use by persons (including children) with reduced physical, sensory or mental capabilities, or lack of experience and knowledge, unless they have been given supervision or instruction concerning use of the appliance by a person responsible for their safety.



Dismantling, repair or alterations should only be carried out by professional technician as otherwise you may be subject to electric shock, may cause fire or get injured.



This washing machine is strictly prohibited to get close to the locations with candle, mosquito-repellent incense, dog-end or other kinds of open flame.

(To avoid injuries caused by the lock damage.)



## ⚠ WARNING

### For power plug and cord

- **Please use the single socket with special voltage and current matched with plug marked specification.**

The share of the same socket with other electric appliances may cause fire due to excessive.



- **Thoroughly wipe the power plug when dirt is adhering the prong or around the base of the prong.**

Failure to do so may cause a fire.



- **Do not pull the wire from the socket when unplugging the unit.**

To avoid electric shock or fire cause by short circuit may result.



- **Electricity supply must be unplugged with dry hands during maintenance and repair.**

Otherwise, electric leakage causing injuries may occur. If the power cord or supply cord is damaged, the manufacture or its service agent or similarly qualified person must replace it in order to avoid a hazard.



- **Please unplug the unit when not using the unit for a long period of time.**

Electric shock or leakage may occur due to deformation of plastic parts of the unit.



### For tub and main unit

- **Do not put your hand into the basket until it has stopped completely.**

Even when the spinning of the basket is slow, there is still a danger of being caught in the motion, resulting injuries. Particular attention should be paid when children are around.



- **Do not put your hand into the washing or spinning basket during the washing and rinsing process.**

Even when the spinning is slow, hands may be trapped by clothes. If necessarily, please press pause button, and put your hands into the basket after it has stopped completely.



### During use

- **Do not put water in direct contact with the unit during maintenance and repair.**

This may cause short circuit or electric shock.



- **Do not put gasoline, benzine, alcohol, thinner of fabrics with these stains into or near to the washing machine.**

To prevent fire or explosion which may cause injuries.



- **Washing machine should not be installed in humid place or in places exposed to wind and rain.**

Otherwise, electricity leak causing electric shock or fire may occur.



- **Keep hands and feet away from the bottom of the washing when it is motion.**

Ports in motion beneath the unit may cause injuries.



- **Do not stand on or put weight on the top of the unit.**

Otherwise, deformation and damage may result causing injuries.



- **Do not connect to the hot water supply, if use warm water, water of above 50°C should not be used for washing.**

Electric shock or leakage may occur due to deformation of plastic parts of the unit.



## ⚠ ATTENTION

- **Do not wash, rinse and spin the water proof fabric or cloth.**

Sleeping bag, raincoat, cover of skiing, utilities, bicycles, cars and motors. Otherwise may lead to injury by abnormal vibration during spinning or damage the washing machine, wall, floor and clothes.



- **Please turn off the water tap when not using the unit.**

To prevent damages caused by water leakage.



- **Clean washing machine**

Use soft clothing to wipe off the water or dirt on the surface of the washer.

- **Do not spray water directly to the washer body.**

- **Detergent, propellant and other chemicals are not allowed to use to avoid the damages on the surface.**



- **Water supply hose should be tightly screwed to the unit.**

Failure to do so may result in water leakage. Used for a long period of time, the unit may result in water leakage caused by loosen union nut. So please check it in time and screw tightly again.

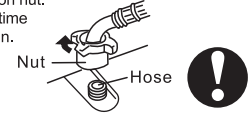

- **Check water supply hose connection by turning on the water before washing. To prevent damages caused by possible water leakage due to loosen screw or not tightly.**

- **The new hose-sets supplied with the appliance are to be used and that old hose-sets should not be reused.**

- **Do not block the ventilation openings on the bottom of washer by carpeting when the water is installed on a carpeting floor.**



## Care and Maintenance

### Clean lint filter (Lint Filter is easily destroyed parts)

- Suggest clean it every week.



- 1 Take out the lint filter.
- 2 Pull out the scraps and wash the lint filter in the water.
- 3 Install the Filter (aim the frame claw to the groove below.)

### Clean hose filter

- Suggest clean it every 6 months.

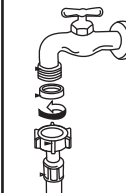

- 1 Turn the nut of water supply hose counter clockwise, take down water hose.
- 2 Clean the crud with a toothbrush.
- 3 Install the clean water hose.

### Clean the water inlet Valve

- Suggest clean it every 6 months.



Water Inlet

- **After long time use, The water inlet mesh bag may be blocked with crud, please load off the water inlet hose, take out the water inlet mesh bag from the water inlet valve, clean the mesh bag, then assemble the mesh bag in the valve and load the water inlet hose.**

# Names of Parts

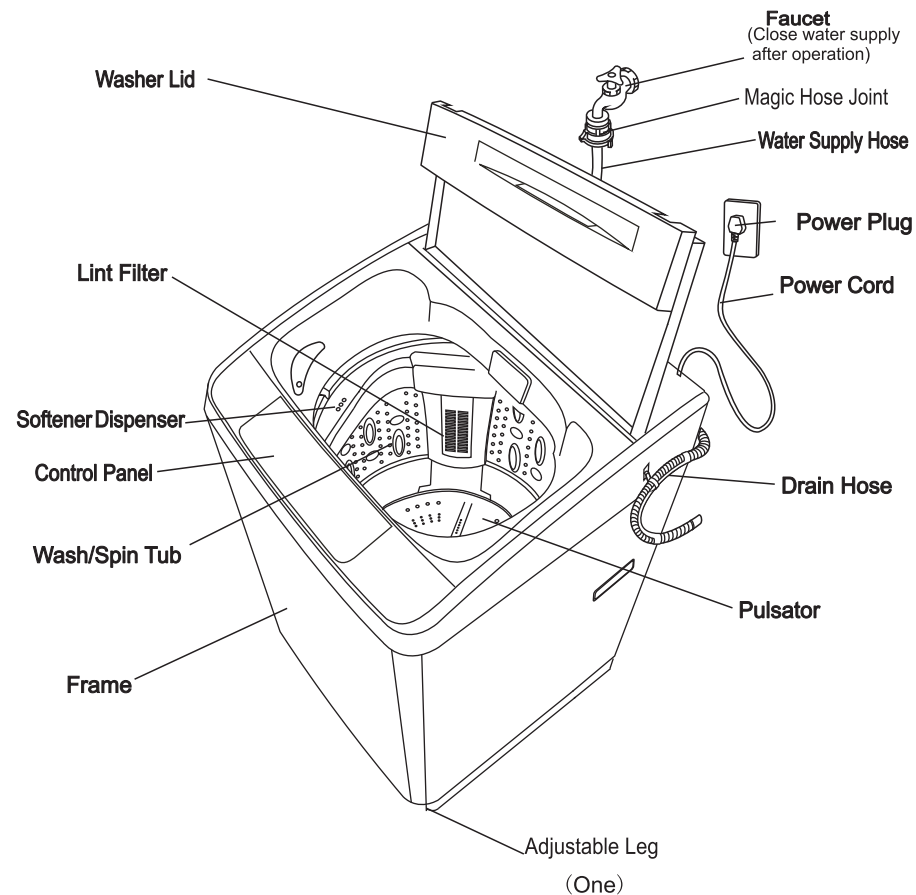

- \* Do not tie the power cord in a bundle during operation.
- \* New hose-sets supplied with the appliance are to be used and old hose-sets should not be reused.

## Accessories

Instruction manual (1 book)	Drain Hose (1 piece)	Water Supply Hose (1 piece)	Bottom Cover (1 piece)	Screw (1 piece)

# Installation Instructions I

## Installing the Bottom Cover

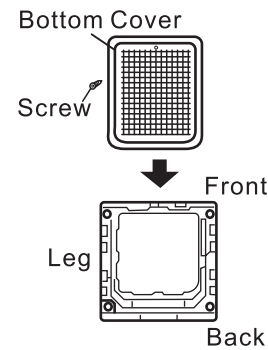

- 1 Put out the bottom cover and in the part bag's bolt.
- 2 Gently lay down the back side of washer on a soft mat or cushion. (Be careful not to dent the Frame.)
- 3 Insert the attached Bottom Cover into the hooks of Leg by straightly pushing until it reaches into the back hooks.
- 4 Fasten the Bottom Cover with a screw.
- 5 Gently set the washer upright.

## Location of Washer



- 1 Choose a dry location out of sunlight for the washer.
- 2 Install the washer on a stable and level surface.

- 3 Adjust the Adjustable Leg of washer if necessary to make the washer level as shown in the figure.

- The maximum permissible inclination of the supporting surface is 2°.

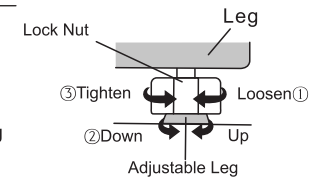

## CAUTIONS

- The washer must be installed so that its bottom opening will be not obstructed by the carpet etc.
- If the washer installed on the carpet floor or big stretch floor it may take big vibration.

# Installation Instructions II

## Connecting the Water Supply Hose

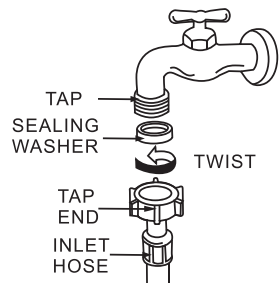

- 1** Check that sealing washers are firmly seated.
- 2** Attach the curved end of the hose to the inlet valve of the washing machine, tighten the coupling nuts securely by hand.
- 3** Attach straight end of the hose to the tap. Tighten the coupling nuts securely by hand.
- 4** Turn on the taps and check for leaks. Tighten the coupling nuts firmly if there is any leakage. If water pressure is strong, close the water tap completely then open it slightly.

### CAUTIONS

- Please make sure to keep the height of drain hose below 1000mm during washing, otherwise, the washer mightn't work properly.
- Do not use water which is hotter than 50°C.
- If the water supply hose does not match with your faucet, please consult your dealer.

## Installing Water Supply Hose to the Washer

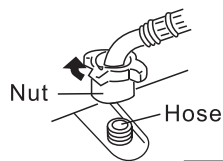

- Turn the nut clockwise till the nut turned tight while holding the hose.

- Turn the nut counter clockwise after turning the faucet off when you want to detach the water supply hose.

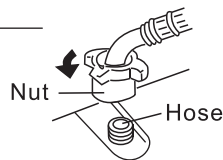

### CAUTION

- Please make sure to keep the height of drain hose below 1000mm during washing, otherwise, the washer mightn't work properly.

# Installation Instructions III

## For high draining level installation

## Installing the Drain Hose

- 1** Connect the water drainage hose with the water drainage joint on the back of the body. Fully insert it into the position to avoid leakage.

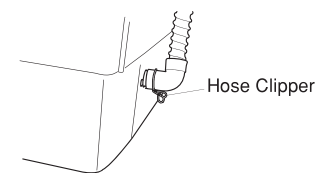
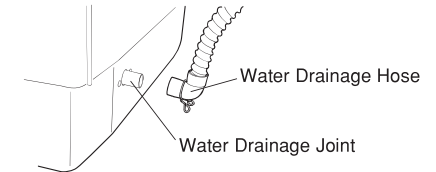

- 2** After the connection is completed. Please use hose clipper to clamp the water drainage hose to avoid falling off.

- 3**
  - ① Insert the fixing holder of water drainage hose into mounting hole.
  - ② As shown below, rotate the fixed leg for 90 degree into the hole.

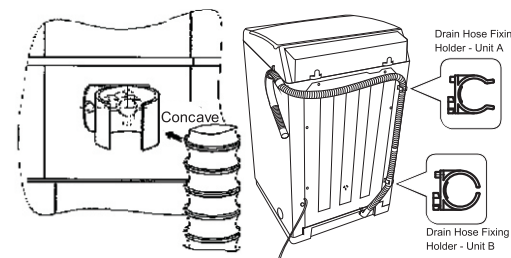
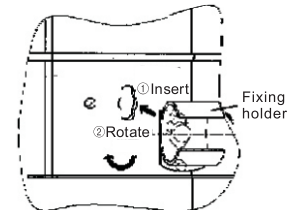

- 4** Pull the water drainage hose straight, concave to fix into the fixing holder of water drainage hose.

### CAUTION

- Please make sure to keep the height of drain hose below 1000mm during washing, otherwise, the washer mightn't work properly.

# Installation Instructions IV

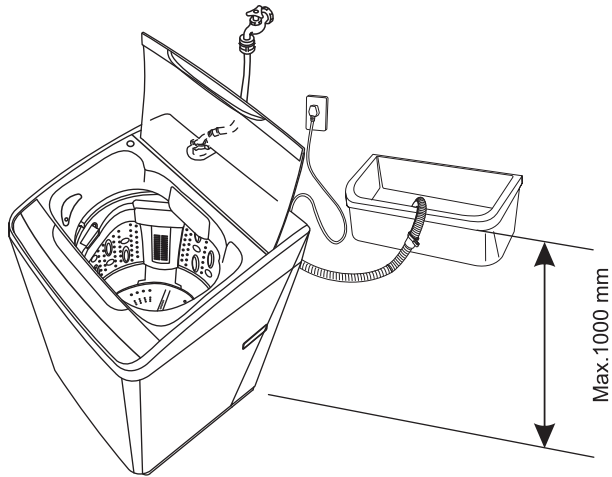

- Please make sure to keep the height of drain hose below 1000mm during washing, otherwise, the washer mightn't work properly.

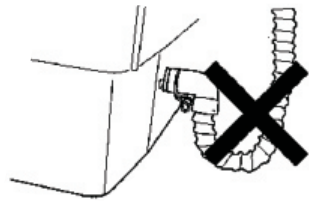

- Be sure not to install the water drainage hose at a position lower than water drainage joint, otherwise, it could lead to difficulties in water drainage.

## ! CAUTIONS

- Do not release the water drainage hose lest the water is splashed.
- Do not use extended water drainage hose.
- Do not immerse the tail of the U-shaped hose in the water.

# Installation Instructions V

## Extension of the Drain Hose

Extension Hose	Height	Length
Not straight	Max.15cm	Max.1m
Straight	—	Max.3m

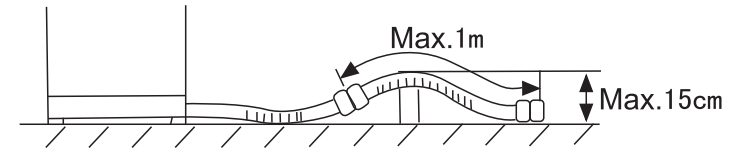

## ! CAUTION

- When extending the external Drain Hose, please follow the below figure for the length and height.

# Names and Function of Control Panel

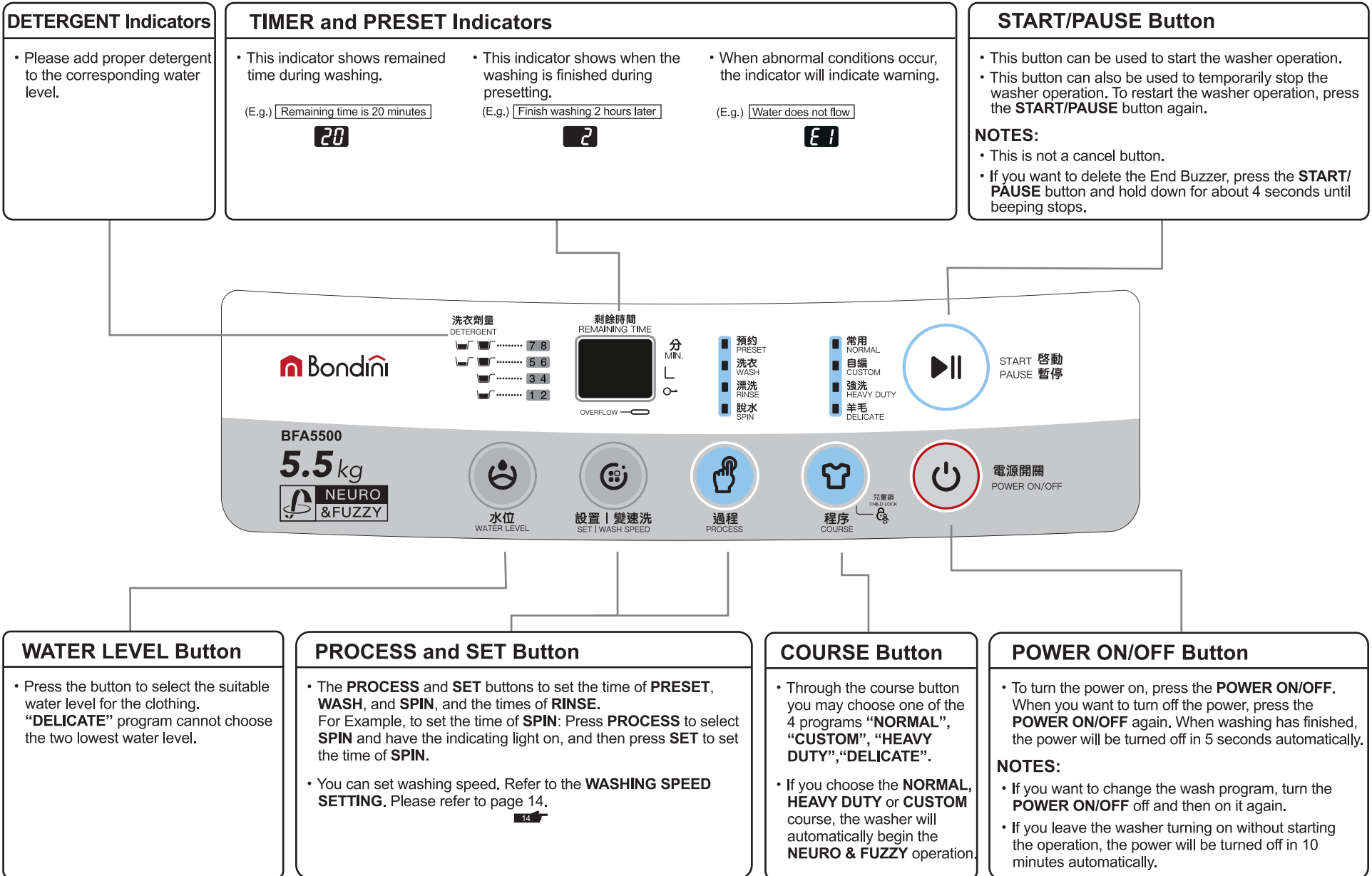

# Normal Usage

## 1 Preparation

- 1.1 Make sure to fit the Drain hose.
- 1.2 Connect the water supply hose to the faucet and turn the faucet on.
- 1.3 Plug the Power Cord into a socket.
- 1.4 Put clothes inside.

## 2 Press POWER ON/OFF button

## 3 Press START/PAUSE button









- Sensor tests the clothes weight automatically. (For NORMAL/CUSTOM/HEAVY DUTY) Auto choose the proper water power, water level, wash/spin times and rinse times.
- It is not available for the 2 lowest water levels. Need manually set if needed.

## 4 Use recommended amount of detergent as shown in chart.

## 5 Close the washer lid

- The washer will alarm and stop working before spinning if the washer lid is not closed.

### DETERGENT AND LOAD RECOMMENDATIONS

Water Level	1	2	3	4	5	6	7	8
Water Volume (Approx. L)	14	18	22	26	30	34	38	45
Detergent Indicators								
Powdered detergent volume (g)	10 ~ 15	15 ~ 20	20 ~ 26	26 ~ 32				
Other detergent volume	You may adjust the detergent volume according to the type of detergent follow recommendations on package.							

## CAUTIONS

- You can use softener, pour the softener slowly so Softener Dispenser before washing.
- Too much detergent causes poor rinsing and too little detergent causes poor washing.

## Simple and Easy Usage for Normal

1. Finish preparation for washing.
2. Press **POWER ON/OFF** button.
3. Press **COURSE** button to choose **NORMAL**.
4. Press **PROCESS** button to choose **WASH, RINSE or SPIN**.  
Once the indicating light is on, that single process is successfully chosen.
5. Press **SET** button to set the time for **WASH and SPIN**, or times for **RINSE**.  
And press **WATER LEVEL** button to choose the water level for **WASH and RINSE**, if needed.
6. Press **START/PAUSE** button to start.

## How To Use Program and Process I

1. Preparation: Fit the Drain hose, turn the water supply faucet on, plug the Power plug into a socket, put clothes inside.
2. Press **POWER ON/OFF** button.
3. Press **PROGRAM** button to choose the course you need according to the clothes.  
Please refer to below chart for course choosing.

### PROGRAM CHOOSING GUIDE

Program	Water Power	Suitable clothes
NORMAL	Standard	Normal clothes
CUSTOM	Standard	Not very dirty clothes
HEAVY DUTY	Strong	Dirty clothes like working coat
DELICATE	Soft	Women underwear, articles with embroider

4. Press **PROCESS** button to choose **WASH, SPIN** time, **RINSE** times.

• **WASH time indicating:** 0 → 1 → 2 → ... → 19 → 20 minutes  

• **RINSE times indicating:** 0 → 1 → 2 → 3 → 4  

• **SPIN times indicating:** 0 → 1 → 2 → ... → 8 → 9 minutes  

(Except the **DELICATE** program).

0 → 1 → 2 → 3 minutes (For **DELICATE** program).  

5. Press **WATER LEVEL** button to choose proper water level and then put detergent.
6. Press **START/PAUSE** button.
7. Close the washer lid.

- If you want to change **PROGRAM** or **PROCESS** during operation, please switch off power, restart power and choose your needed course you need.

# How To Use Program and Process II

OPERATION STATUS FOR THE PROGRAM			
Program	Wash Time (minutes)	Rinse Type and Rinse Times	Spin Time (minutes)
NORMAL	5 ~ 12	Water Saver Rinse 2 times	4 ~ 5
HEAVY DUTY	7 ~ 14	Water Saver Rinse 2 times	7 ~ 8
DELICATE	6	Water Saver Rinse 2 times	2
CUSTOM	10	Water Saver Rinse 2 times	5

- Possible the total time is not same due to different water pressure.

## The Preparation of Laundry Before Washing

- Make sure that nothing remained in pocket. (Pin, coin or something like possibly damage clothes or washing machine, and the extra noise occurred may cause trouble to washing machine).
- Wool items like women underwear, articles with embroider, nylon etc, should be placed in laundry net for extra protection.
- Close the fastener and tie loose laces.
- Brush the dirty parts like dust and sand.
- Put light clothes down. Please pause operation and put it into water when it floats up.
- Please separate washing white clothes from coloured clothes, coats from underwear.

# Various Functions

## DELICATE

The water level will be changed to 6 automatically when DELICATE mode set. While you can adjust it from level 3 to level 8 by hand according to the delicate or the bulky items size.

## ORDER OF OPERATIONS

1. Open the washer lid and press **POWER ON/OFF** button.
2. Press the **COURSE** button till the light of **DELICATE** turn on.
3. Pour into the liquid detergent, dissolve it into a 5L warm water (about 30°C) if the detergent is used, then pour it into the laundry slowly.
4. Put the wool cloth into the washing machine.
5. Press the **WATER LEVEL** button. (adjusting the water level accordingly)
6. Close the washer lid.

## WATER LEVEL SETTING

Washing with low level water and rinsing with high level water will help more clean washing and completely rinsing.

## METHOD OF SETTING

Press **WASH** button to set wash time, press **WATER LEVEL** button to set water level for wash, press **RINSE** button to set rinse times. Then press **WATER LEVEL** to set water level for rinse, press **SPIN** button to set spin time, press **START/PAUSE** button to start. By this, wash and rinse will work according to the water levels set separately.

## TWO CLEAN STEPS FUNCTION

The washer will start washing when water to the level below 2 levels as set. By this, the washer starts working with more density of detergent.

- This function won't be effected when select level 1 or level 2 water, and **DELICATE** course.
- When **SOAK** is selected, this function will not be effected after soaking.

## REMEMBER FUNCTION

When select **NORMAL**, **QUICK** or **HEAVY DUTY**, 15 seconds after starting, the washer will remember this program and starts same next time working.

- This function is not available for **DELICATE** course.
- **WATER LEVEL** will not be remembered.
- **NORMAL**, **HEAVY DUTY** program, **NO MEMORY OF WASH, RINSE, SPIN** process of the artificial setting.
- The memory will be lost if pull out the plug.

## CHILD LOCK FUNCTION

Press on **POWER ON/OFF** button to switch on the power, and press **COURSE** button for 4 seconds till a sound from buzzer. To restore it, repeat above.

- After setting the **CHILD LOCK** function, if you open the top lid more than 5 seconds during the washing process, washing machine will stop running and sound a buzzer alarm.

## DELETE THE END BUZZER

Press **POWER ON/OFF** button to switch on the power, and press **START/PAUSE** button for 4 seconds till a sound from buzzer. To restore it, repeat above or pull out the plug.

## WASHING SPEED SETTING

During the process of **WASH** and **RINSE**, press "**SET/WASH SPEED**" button to adjust the washing speed, and then the LED will display in turn: **H0** (standard washing speed), **H1, H2, H3, H4** (faster washing speed), **L1, L2, L3, L4** (lower washing speed).

# Trouble Shooting Guide

When the following problems occur, the microcomputer will detect the abnormal condition and an electronic buzzer sounds for approximately 10 seconds and the indicators flash as shown below. At the same time, the washer stops operation.

Kind of Trouble	Trouble Indication	Where to Check
The washer does not work at all.		<ul style="list-style-type: none"> <li>• Press the <b>POWER ON/OFF</b> button.</li> <li>• Press the <b>START/PAUSE</b> button.</li> <li>• Check whether power failure occurs.</li> <li>• Check whether the fuse or circuit breaker has been activated.</li> </ul>
Water does not flow into the Wash/Spin Tub.	E1	<ul style="list-style-type: none"> <li>• Turn on the water supply faucet.</li> <li>• Check whether the water supply has been cut off.</li> <li>• Check whether the metal filter of the Water Inlet is clogged.</li> <li>• Check the washer has been freezing.</li> <li>• Check whether water pressure is too low.</li> </ul>
Water does not drain out.	E2	<ul style="list-style-type: none"> <li>• Check whether the height of drain hose is more than 1000mm.</li> <li>• Check whether the drain hose is clogged.</li> </ul>
The washer does not spin.	E3	<ul style="list-style-type: none"> <li>• Check whether the laundry is clumped on one side of the Wash/Spin Tub.</li> <li>• Check whether the washer is on the level surface.</li> </ul>
	E4	<ul style="list-style-type: none"> <li>• Close the Washer Lid.</li> </ul>
The buzzer keeps beeping.	E5	<ul style="list-style-type: none"> <li>• Check whether the <b>CHILD LOCK</b> is set.</li> <li>• Close the Washer Lid.</li> </ul>
Other troubles.	ER	<ul style="list-style-type: none"> <li>• Press the <b>POWER ON/OFF</b> button to turn off the power, call your service-person or dealer.</li> </ul>
	EC	

## NOTES:

- The trouble indicators can be released by pressing the **START/PAUSE** button once if you want to release the emergency stop.  
Then press the **START/PAUSE** button again to restart the operation.

# No Trouble Conditions

- 1 During Washing or Rinsing, still there is Water in letting. This is possibly automatic water adding due to water level decrease.
- 2 Spin tub turns or stops timely at the beginning of spinning. This is intermittent spinning for better spin effect.
- 3 Water is letting and rinsing sometimes during spinning. This is automatic lean-correction due to clothe is not equally inside.
- 4 There is sound like water flow after spinning. This is the sound of balance liquid in Balance ring. It is for reducing vibration of spinning.
- 5 Control panel keeps warm after power off, this is caused by Remembering circuitry working.
- 6 Power off during working and the washer could not continue working. should set the program again.

# 目錄

## 使用前須知

注意事項	20 -22
保養須知	22
附件說明	23
各部件名稱	23
安裝介紹	24 -28
功能介紹	29 -30

## 簡易使用

一般的使用方法	31
選擇『過程』、『程序選擇』的使用方法	32 -33
洗衣要領	33

## 進階功能

多種多樣的機能	
水量調節功能	34
二步淨洗功能	34
記憶功能	34
兒童鎖功能	34
取消終了蜂鳴聲	34

## 如果需要時



故障排除指南	35
並非故障的情況	36
規格	封底

# 注意事項

請務必遵守

使用前請詳細閱讀『注意事項』並正確使用。

- 為了防止對使用人和他人造成傷害或財產損壞，現就安全方面需要務必遵守的事項，作如下說明

 <b>警告</b>	此標示欄的內容為『有死亡或受傷的可能性』。
 <b>注意</b>	此標示欄的內容為『有受傷及僅有物品損壞的可能性』。

- 要求遵守的事項，按下列圖示區分並說明。

 『警告或提醒注意』的內容。	 『禁止』的內容。	 『注意』的內容。
---	--	--

## 警告

### 關於電源插頭及電源線

- 請務必正確接地。為防止漏電事故的發生。



- 手潮濕時請勿插入或拔下電源線插頭。以避免觸電的危險。



- 電源線的保護。使用時請注意電源線外皮是否受損傷，有無不合理彎曲或拉伸及重物壓住變形等現象，電源線破損導致絕緣不良，這是發生觸電、火災的原因。電源線損壞時，需由專業維修人員維修更換。

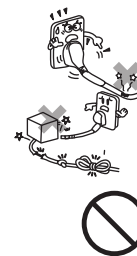

### 對洗衣槽及本體

- 不要讓兒童在洗衣機上或洗滌/脫水槽內玩耍。



- 如果兒童不慎掉入洗滌脫水桶內，會產生嚴重的傷害。
- 該電器不適用於人群(包括兒童)：具有身體障礙、感官障礙、精神障礙者，或缺乏必要經驗與常識者，必須要在安全監護人的指導和監督下才可以使



- 不可改裝，非專業維修人員禁止拆解及修理洗衣機。
- 會造成火災、觸電、受傷。
- 發生故障時請向本公司報修。



- 請勿靠近煙火，請勿將點燃的蠟燭、香煙、蚊香及水壺放在洗衣機上，這是造成火災及變形的主要原因。





## 警告



### 關於電源插頭及電源線

- 勿過度彎曲、拉扯、扭轉電源線。會造成電源線破損導致火災、觸電。
- 電源線插頭的灰塵等要定期清除。若灰塵堆積插頭上，會因濕氣造成絕緣不良引起火災。
- 電源線插頭插入或拔出時，手指須緊握插頭絕緣部分施力，請勿觸碰插頭的金屬插片或施力於導線端以避免觸電，導致電源線內部導線斷裂。
- 在移動洗衣機時，務必先拔下電源線插頭。
- 長時間不使用洗衣機時，請拔掉電源。可能會因為漏電或者觸電造成塑料變形。
- 如電源線損壞，為避免危險，必須由生產商、其代理商或具資格人員替換。
- 保養時請務必從插座上拔下電源線插頭，此外手潮濕時請勿插拔電源線插頭。
- 會造成觸電、受傷。







### 對洗衣槽及本體

- 當洗衣機運轉時，不要將手伸進洗滌脫水桶。
- 如手碰到洗滌脫水桶可能會受到傷害。
- 脫水時如洗滌上蓋打開15秒內，洗滌脫水桶不停止轉動，請立即關掉電源，並盡快聯絡本公司客戶服務電話。

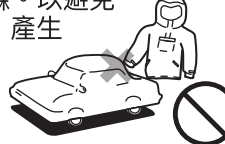
### 使用時

- 洗衣機本體各部分，請勿直接用水沖洗。
- 以避免絕緣不良，導致觸電的危險。
- 請勿洗滌沾有汽油、煤油、稀釋劑等揮發性溶劑的衣物。這樣可能引起火災或爆炸。
- 避免安裝於潮濕及雨淋處。電器絕緣不良，成為漏電或故障的原因。
- 洗衣機運轉中，請切勿嘗試接觸內部運作部件，以避免受傷的危險。
- 請勿將幼兒及貴重物品放置在洗衣機上。以避免部件變形或破損導致危險的發生。
- 熱水會使塑料部件變形，這是發生故障的原因。

## 注意

- 防水性或不吸水的洗滌物不可以放在洗衣機內洗滌。以避免洗衣或脫水時，產生異常振動。(如雨衣、車套)
- 洗衣機不使用時應關閉水龍頭，以避免進水軟管破損或脫落，造成漏水事故的發生。
- 應將電源線插頭拔掉，以防止發生火災或其他事故。
- 洗滌之前檢查供水軟管連接處，螺釘有否鬆開或不緊密的情況，以避免造成水泄漏。
- 使用軟布擦除箱體上的水及污跡時，不要將水直接潑灑在箱體上，這樣做可能會造成短路及觸電。
- 不要使用刷子、上光粉、汽油或其他易揮發性材料擦拭洗衣機。這樣做可能會損壞機身表面塗層或塑料部件。
- 供水管應擰緊，否則可能會導致漏水。水管接口處長時間使用可能會導致螺母鬆動造成漏水，請檢查時再次擰緊。



## 保養須知

### 過濾網的清洗 (過濾網為易損部件)

■每次用完及時清洗

- 取下過濾網
- 去除大塊毛絨，同時刷去過濾網上的細小絨屑。
- 重新裝上過濾網，安裝時將框部的爪對準下方的溝部放入。

### 接頭的清洗

■建議半年一次

- 取下進水軟管
- 按箭頭方向旋下接頭
- 將清洗乾淨的接頭，進水軟管重新裝上。

### 進水閥口的清理

■建議半年一次

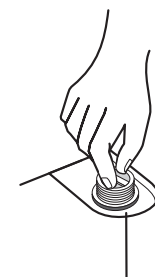

進水閥口

- 臟物積存會影響進水量，請取下進水軟管，取出進水閥口的過濾網，清理網上的臟物後重新裝回去。

# 各部件名稱

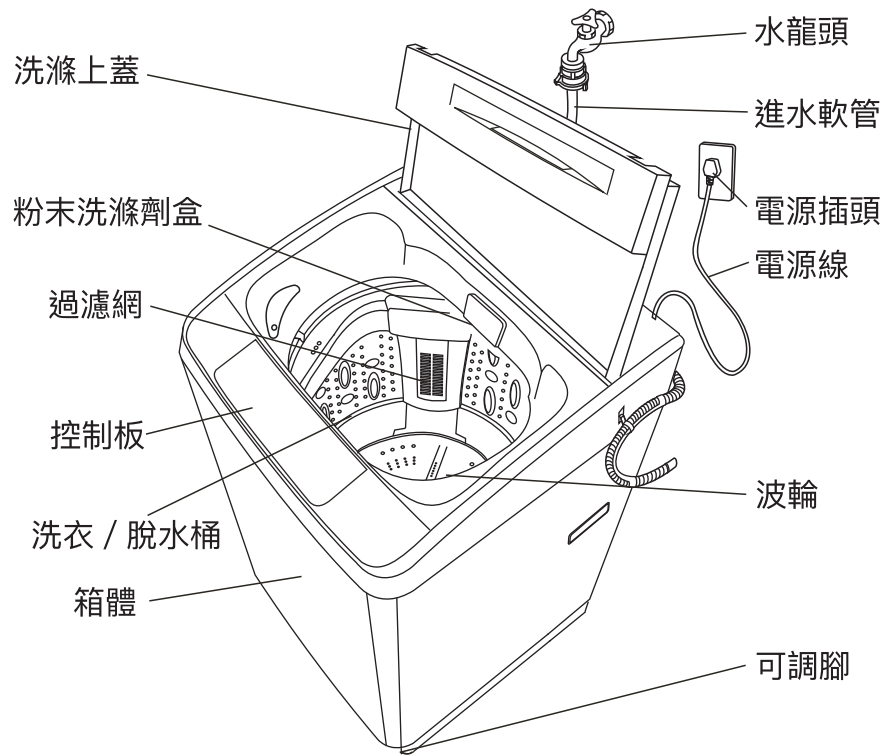

- \* 使用時請勿將電源線捆扎成一束。
- \* 請務必使用附送的新進水管，舊進水管不得使用。

## 附件說明

說明書 (一本)	排水軟管組件 (一根)	進水軟管 (一根)	屏蔽板 (一個)	螺釘 (一個)

# 安裝介紹 (一)

## 屏蔽板的安裝

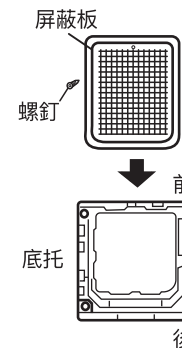

- 1 拿出洗衣機面架保護上的屏蔽板和部件袋中的螺釘。
- 2 將洗衣機向後傾斜，慢慢地放倒在軟墊上。(小心不要磕碰箱體)
- 3 將屏蔽板沿底托卡槽筆直推入，直至其安裝到位。
- 4 用螺釘將屏蔽板與底托固定。
- 5 將洗衣機輕輕扶起放穩。

## 洗衣機的放置



傾斜的地面



不平穩的地面

- 1 選擇乾燥、無陽光直射的地方放置洗衣機。
- 2 將洗衣機安放在堅實平穩的地面上。

- 3 盡量使洗衣機平穩，如有必要可通過調節洗衣機的可調腳來將洗衣機調平。

· 支撐面最大允許傾斜度為2°。

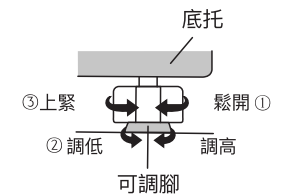

## ⚠ 注意

- 如洗衣機安放在鋪有地毯的地板或彈性較大的支撐臺上時，可能會造成洗衣機的振動。
- 不要讓地毯等鋪墊物堵塞洗衣機底部的散熱孔。

## 安裝介紹 (二)

### 進水軟管的安裝

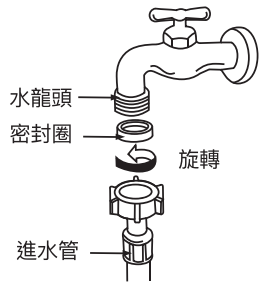

- 1 請檢查密封圈是否良好的固定在軟管的接頭上。
- 2 將進水軟管彎曲的一端連接在洗衣機的進水閥上，用手擰緊進水軟管上的旋緊螺母。
- 3 將進水軟管直的一端連接在水龍頭上，並用手擰緊進水軟管上的旋緊螺母。
- 4 打開水龍頭檢查是否有漏水。如果水管的一端有漏水，請將那端的旋緊螺母擰緊。如果水壓比較大，請關閉水龍頭，然後再緩緩的打開。

### ⚠ 注意

- 洗衣機工作時，排水軟管掛起的高度必須低於1000mm，否則洗衣機可能無法正常工作。
- 請不要使用水溫超過50°C的水。
- 如果您的水龍頭的水管不相配，請聯繫經銷商。

### 將進水軟管連接到洗衣機進水閥

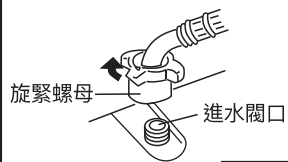

- 按左圖所示，將進水軟管口對準進水閥口，順時針旋轉進水軟管上的旋緊螺母，直至旋不動為止。

- 按右圖所示，進水閥上的進水軟管按逆時針方向旋轉，直至取下進水軟管。

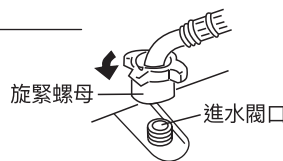

### ⚠ 注意

- 洗衣機工作時，排水軟管掛起的高度必須低於1000mm，否則洗衣機可能無法正常工作。

## 安裝介紹 (三)

### 適用於高去水位安裝

### 排水軟管的安裝

- 1 將排水管連接到箱體背後的排水接頭上。應切實的插入到位以免漏水。

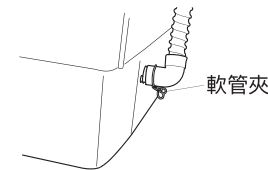
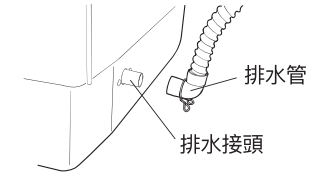

- 2 連接好後，請用軟管夾子將排水管夾緊以免脫落。

- 3 ① 將排水管固定架插入孔中。  
② 按圖示方向旋轉90度，將固定腳旋入孔中。

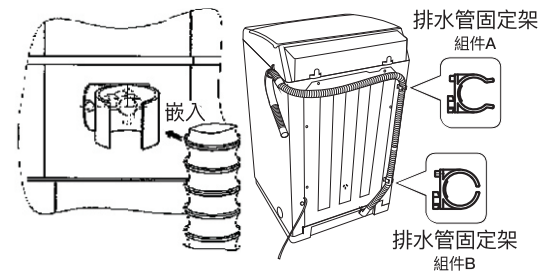
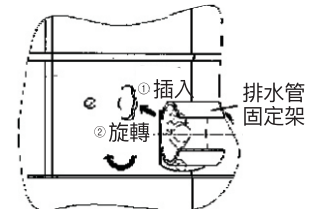

- 4 將排水管拉直，嵌入固定在排水管固定架上。

### ⚠ 注意

- 洗衣機工作時，排水軟管掛起的高度必須低於1000mm，否則洗衣機可能無法正常工作。

## 安裝介紹 (四)

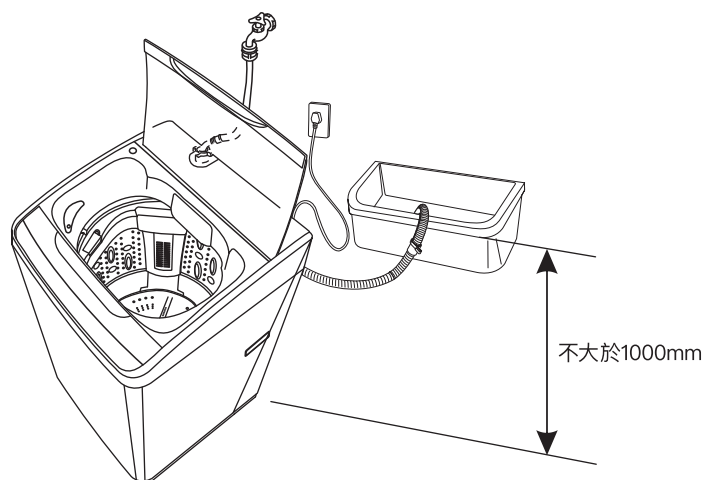

- 洗衣機操作時，排水軟管掛起的高度必須低於1000mm，否則洗衣機可能無法正常工作。

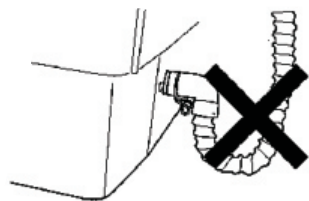

- 排水管安裝時，請勿低於排水接頭，如低於排水接頭可能會導致排水不順。

### ⚠ 注意

- 請勿將排水管放倒，以免水灑落。
- 請勿使用延長排水管。
- 請勿將排水管尾部的U型管浸在水中。

## 安裝介紹 (五)

### 排水軟管的延長

排水軟管的延長	延長高度	延長長度
中間有台階	15cm以內	1m以內
中間無台階	—	3m以內

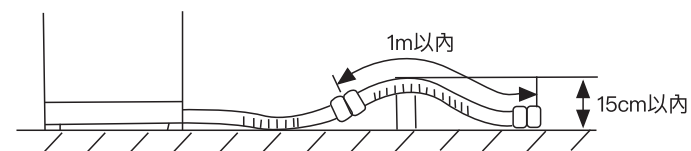

### ⚠ 注意

- 當排水軟管長度不足時，請向銷售商或本公司購買排水軟管，進行對接即可。

# 功能介紹

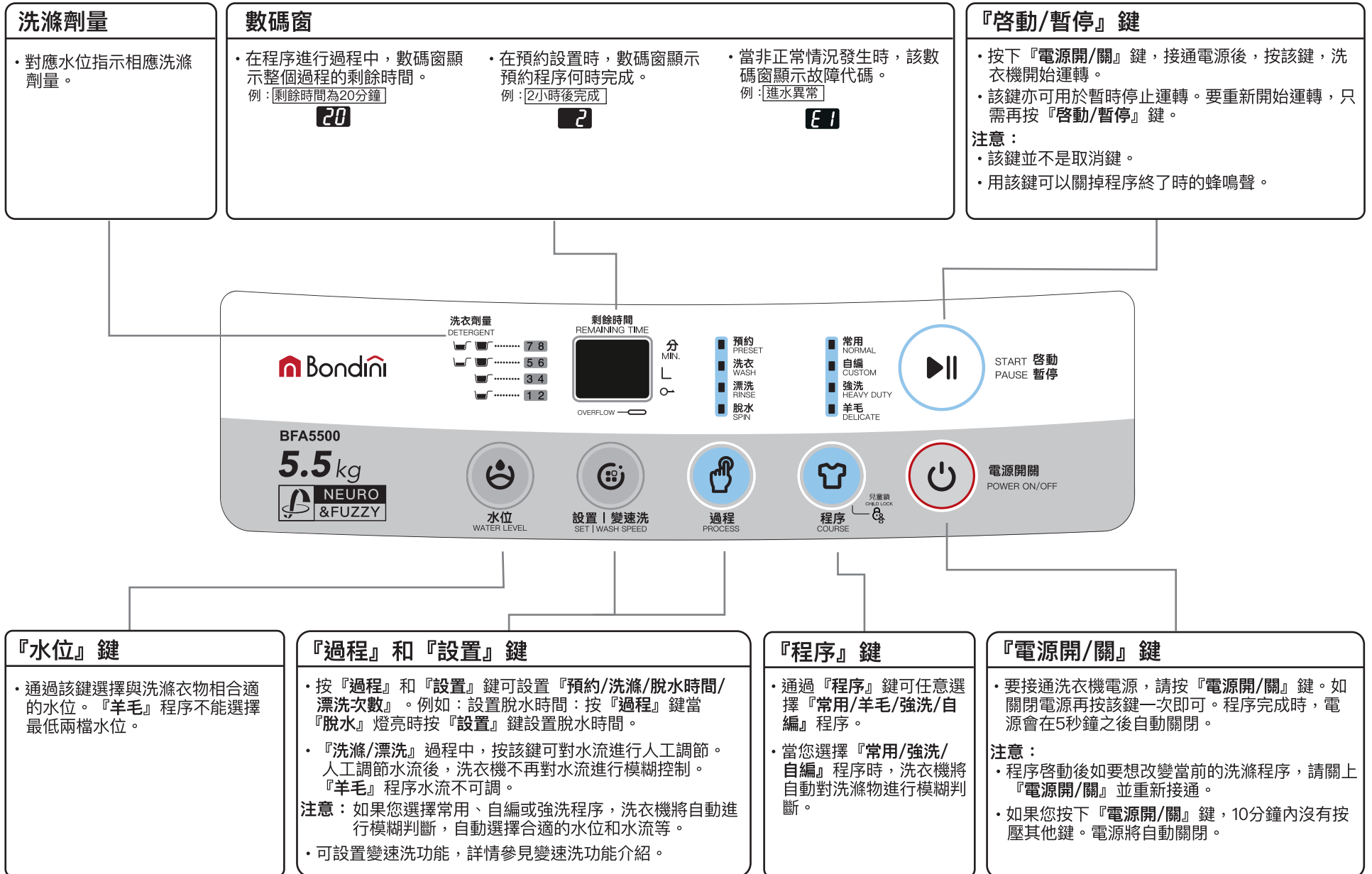

# 一般的使用方法

## 1 使用洗衣機事前準備及步驟。

- 1.1 接好並放下排水軟管。
- 1.2 將進水軟管接到水龍頭上，並擰開水龍頭。
- 1.3 將配源插頭插入電源插座。
- 1.4 放入洗衣物。

## 2 按『開/關』鍵。

## 3 按『啓動/暫停』鍵。

- 洗衣機將自動檢測衣物量(『常用/強洗/自編』三種程序時)，自動選擇水位/水流/洗衣脫水時間及漂洗方式等。
- 如最低兩檔水位不能自動選擇，需要時可人工設定。

## 4 蓋好洗衣機上蓋。

- 如洗衣機上蓋沒有關閉，脫水時洗衣機將會停止運作並有蜂鳴聲提示。

### 洗滌劑及推薦用量

水位	1	2	3	4	5	6	7	8
水量(L)	14	18	22	26	30	34	38	45
洗滌劑量指示								
粉末合成洗滌劑用量(g)	10 ~ 15		15 ~ 20		20 ~ 26		26 ~ 32	
其他類型洗滌劑	按相應洗滌劑說明對照使用							

## ⚠ 注意

- 若使用軟化劑，可在洗滌前向軟化劑入口處倒入適量的軟化劑。
- 放入太多的洗滌劑，可能影響到漂洗性能，太少的洗滌劑可能影響到洗衣效果。

### 常用程序的簡易用法

1. 完成洗衣前的準備。
2. 按電源鍵通電。
3. 按程序鍵選擇常用。
4. 按過程鍵單獨選擇洗滌、漂洗或者脫水。指示燈亮表明該過程被單獨選取。
5. 如有需要的話，按設置鍵選擇洗滌和脫水的時間，漂洗的次數。按水位鍵選擇洗滌、漂洗的水位。
6. 按啟動鍵開始。

## 選擇『過程 | 程序』的使用方法(一)

1. 準備：放好排水管，打開水龍頭，將電源插頭插入電源插座，放入洗滌物。
2. 按一下『電源開/關』鍵
3. 根據所洗衣物的種類，按『程序』鍵設定您想要的程序。

各程序的選用參見如下

### 各程序的選用指導

程序	洗滌水流	衣物的種類
常用	標準	一般的洗滌物 (適用於日常洗滌)
自編	標準	每天換洗不臟得衣服
強洗	強	臟污嚴重衣物 (如工作服等)
羊毛	輕柔	女性內衣、有花邊和刺繡的衣物

4. 按『過程』鍵自由選擇浸洗、洗衣、脫水的時間，漂洗次數。
  - 洗衣時間設定顯示：  
0 → 1 → 2 → ... → 19 → 20 分鐘  
↑
  - 漂洗次數設定顯示：  
0 → 1 → 2 → 3 → 4 次  
↑
  - 脫水時間設定顯示：  
0 → 1 → 2 → ... → 8 → 9 分鐘 (『常用/自編/強洗』程序)  
↑  
0 → 1 → 2 → 3 分鐘 (僅『羊毛』程序)  
↑
5. 按『水位』鍵選擇必要的水位，放入洗滌劑。
6. 按『啓動/暫停』鍵。
7. 蓋好洗滌上蓋。
  - 如果您想改變已設定好的『程序』及『過程』鍵。請關掉電源開關再打開，並重新選擇您所需要的程序。

## 選擇『過程 | 程序』的使用方法(二)

各程序默認的運行情況

程序	洗滌時間(分鐘)	洗滌方式及次數	脫水時間(分鐘)
常用	5 ~ 12	蓄水漂洗二次	4 ~ 5
強洗	7 ~ 14	蓄水漂洗二次	7 ~ 8
羊毛	6	蓄水漂洗二次	2
自編	10	蓄水漂洗二次	5

- 各程序運行的合計時間因水壓不同而有所變化。

### 洗衣要領

- 確保衣服口袋內沒有物品。(如釘子、硬幣等可能損傷衣服或洗衣機，產生額外的噪音或使洗衣機發生故障的東西。)
- 將衣服翻過來洗，這樣洗滌過程中產生的線屑不會附著在衣服表面。
- 當洗精細織物時，如女性內衣、飾有花邊的物品、尼龍和薄化織衣料等，應將其放入洗滌用網套中。
- 緊衣服上鬆的帶子並拉上拉鏈，扣好鈕扣。
- 洗滌前先去除衣物上的泥土和沙子。建議在洗較臟的外套前用刷子先洗刷一下。
- 易浮於水面之上的衣物請放入水底，另外，浮上來時請暫停並將其按入洗滌液中。
- 請將厚物與薄物分開洗滌，有色衣物與白色衣物分開洗滌，外衣與內衣、毛巾等分開洗滌。

## 多種多樣的功能

### 洗滌羊毛

用該程序時，水位自動設在第6檔。但您可根據羊毛服裝的大小改變水位，設置成第3~8檔。

### 操作順序

- 擰開水龍頭，按下『電源開/關』並打開洗滌上蓋。
- 按『程序』鍵直到『羊毛』燈亮為止。
- 將液體洗滌劑倒入洗衣機，如您使用洗衣粉，將其充分溶解在5L的溫水中(大約30°C)，然後慢慢地倒入洗衣機中。
- 將羊毛服裝放入洗衣機內 並按入水裏。
- 按『啟動/暫停』鍵。(根據需要，可人工調整水位。)
- 蓋好洗滌上蓋。

### 水量調節功能

為了提高洗滌劑濃度，同時也可以節約用水，洗衣、漂洗可以設定不同的水位，建議以較低的水位洗滌，較高的水位漂洗，這樣可以保證洗得乾淨，漂得徹底。

### 設定方法

在選擇好程序後按『洗衣』鍵設定洗滌時間，按『水位』鍵設定洗滌水位，按『漂洗』鍵設置漂洗次數。再按『水位』鍵設置漂洗水位，根據需要再按『脫水』鍵設定脫水時間，最後按『啟動/暫停』鍵啟動後，洗滌和漂洗將分別按照設定好的不同水位進行。

### 二步淨功能

在洗衣過程中，洗衣機在達到比設定水位低兩檔水位時，進水同時開始洗滌。

- 設定最低兩檔水位時，達到設定水位後開始洗滌。
- 『羊毛』程序無二步淨功能。
- 選擇『浸泡』時，浸泡結束後洗滌時無二步淨功能。

### 記憶功能

當您選擇『常用/強洗/自編』程序時，啟動15秒後，洗衣機將自動記住您所選的程序。下次使用時，打開『電源開/關』，按一下『啟動/暫停』鍵，洗衣機將繼續運行和前一次一樣的程序。

- 執行『羊毛』程序時沒有記憶功能。
- 不記憶水位功能的設定。『常用/強洗』程序時不記憶洗滌、漂洗、脫水的人工設定的過程。
- 拔掉電源插頭或停電後，洗衣機將取消記憶。

### 兒童鎖功能

設定兒童鎖功能後，在運行過程中打開洗滌上蓋5秒以上，洗衣機將停止工作並發出提示音警報。

- 兒童鎖功能的設定：打開『電源開/關』，按住『程序』鍵4秒以上，直至聽到蜂鳴器提示音；取消時，重覆上述步驟，或拔掉電源插頭。
- 設置兒童鎖功能啟動後，所有按鍵都不響應。

### 取消終了蜂鳴聲

取消終了蜂鳴聲的設定：打開『電源開/關』，按住『啟動/暫停』鍵4秒以上，直至聽到蜂鳴器提示音；恢復時，重覆上述步驟。

### 變速洗功能

在洗滌及漂洗過程中，按『設置/變速洗』鍵可對洗滌水流進行人工調節，按此鍵數碼窗依次顯示調節後的水流：HO(標準水流)、H1、H2、H3、H4(水流增強)、L1、L2、L3、L4(水流減弱)。

# 故障排除指南

當下列問題出現時，微電腦將對不正常狀態進行檢測，並發出大約10秒鐘的電子蜂鳴警報提示聲，數碼窗將按下表所示狀態閃爍。

故障類型	故障顯示	原因
完全不運轉		<ul style="list-style-type: none"> <li>• 是否停電。</li> <li>• 電源開關是否接通。</li> <li>• 是否按了『啓動/暫停』鍵。</li> <li>• 電源的保險絲或電路的電流斷路器是否完好。</li> </ul>
不進水或進水量很少	E1	<ul style="list-style-type: none"> <li>• 水龍頭是否打開。</li> <li>• 是否停水。</li> <li>• 過濾網是否被堵塞。(參見第22頁)</li> <li>• 洗衣機進水管是否已凍結。</li> <li>• 水壓是否太小，長時間進水未達到設定水位。</li> </ul>
不排水	E2	<ul style="list-style-type: none"> <li>• 排水口是否過高(超過1.0米)</li> <li>• 排水口是否被堵塞。</li> </ul>
不脫水	E3	<ul style="list-style-type: none"> <li>• 洗滌物是否偏向洗滌桶一側。</li> <li>• 洗衣機安放是否平正。</li> </ul>
	E4	<ul style="list-style-type: none"> <li>• 洗滌上蓋是否打開。</li> </ul>
不洗滌	E5	<ul style="list-style-type: none"> <li>• 檢查兒童鎖模式是否設置。</li> <li>• 洗滌上蓋是否打開。</li> </ul>
其他	EA	<ul style="list-style-type: none"> <li>• 請關閉『電源開/關』，並盡快撥打本公司客戶服務電話。</li> </ul>
	EC	

注意：

- 按『啓動/暫停』鍵，故障顯示被解除。如您檢查各項並排除故障後，再按『啓動/暫停』鍵，洗衣機將繼續運轉。如仍有異常，請拔下電源插頭，並盡快撥打本公司客戶服務電話。

# 並非故障的情況

- 1 洗滌或漂洗時有時有進水現象，這是水位下降而進行的自動補水。
- 2 在脫水開始時，脫水桶時停時轉，這是為達到更好的脫水效果而設計的間歇脫水。
- 3 脫水中途有時出現漂洗現象，這是由於脫水時衣物偏置，而自動進行的脫偏糾正。
- 4 脫水結束後，有水殘留的聲音，這是為了降低脫水振動而設計的平衡環內平衡液的流動聲。
- 5 在運轉後關掉『電源開/關』，控制板局部仍可以感覺到輕微發熱，這是由於記憶電路電子部件的發熱造成的。
- 6 程序運行中停電，來電後不能繼續運行，請重新設定。